

MESH

design Francisco Gomez Paz

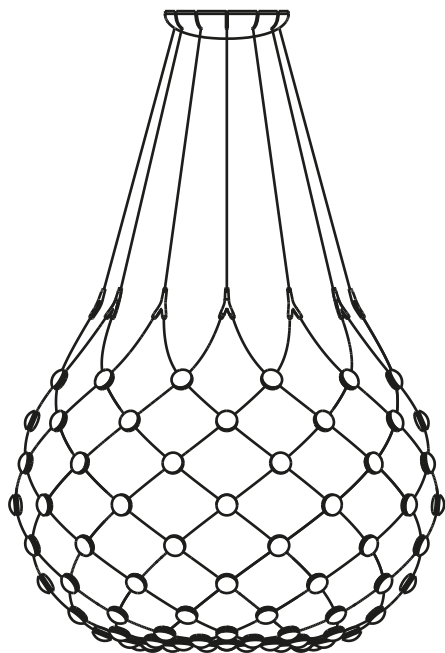

**LUCE
PLAN**

D86/T1..T5/1..8
D86N - D86NPI



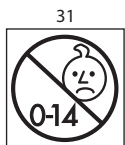
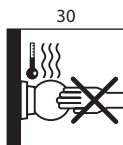
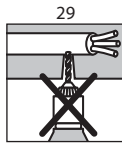
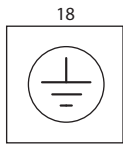
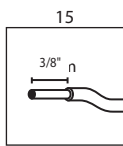
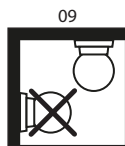
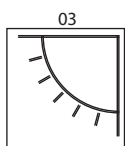
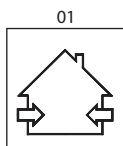

D86/T1/1

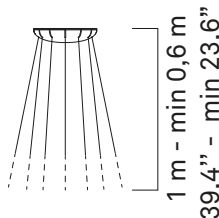

kg 1,5kg lb 3,3 lb

D86/T5/1

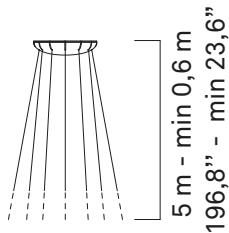

kg 1,7kg lb 3,75 lb

+

D86N

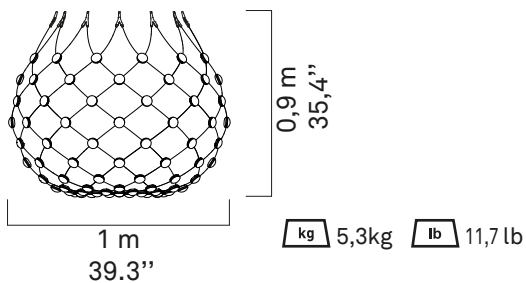

D86/T1/8

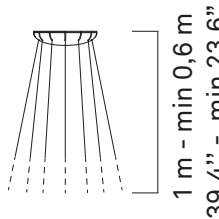

kg 1,2kg lb 2,65 lb

D86/T5/8

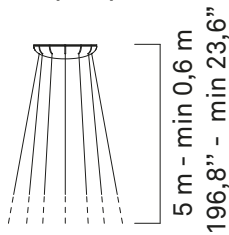

kg 1,4kg lb 3,1 lb

+

D86NPI

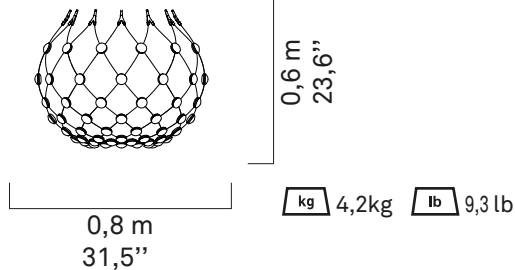

D86/T1/1

D86/T5/1

D86/T1/8

D86/T5/8

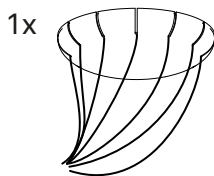

D86/N

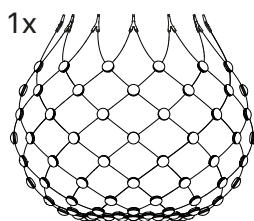

D86/NPI

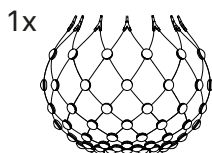

1

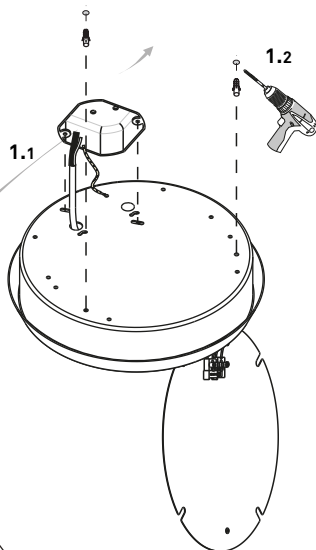
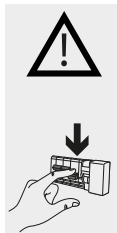

⏏ yellow/green
jaune/vert
amarillo/verde

N white
blanc
blanco

L black
noir
negro

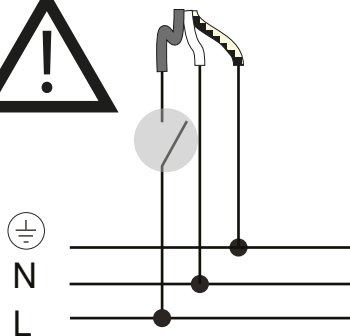
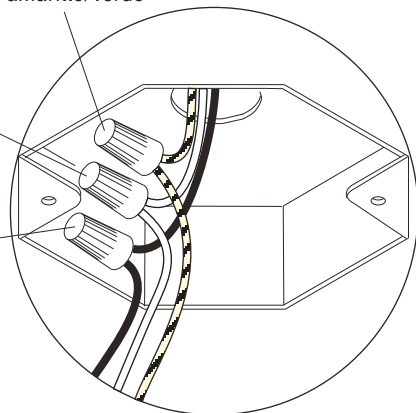

22
(0,1%) MAX (100%)

2

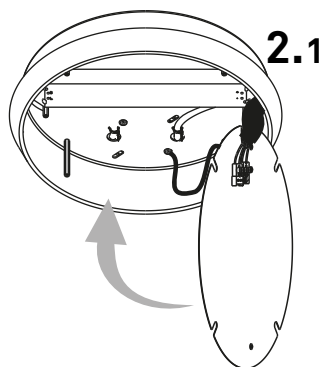

2.2



Click!

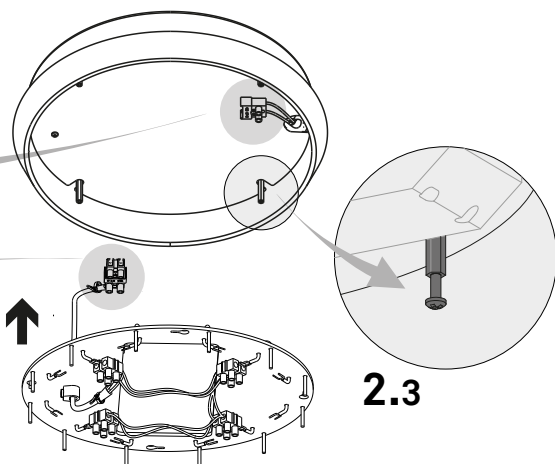

2.3

2.4

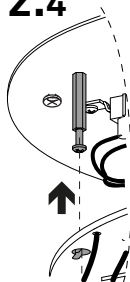

2.5

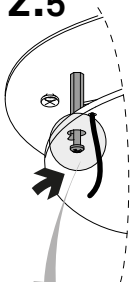

2.6

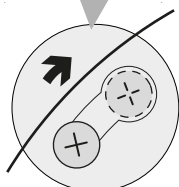
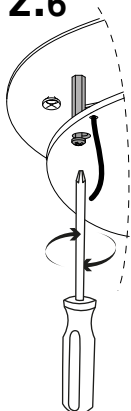

3

D86/T1/1 | D86N
D86/T5/1 |
D86/T1/8 | D86NPI
D86/T5/8 |

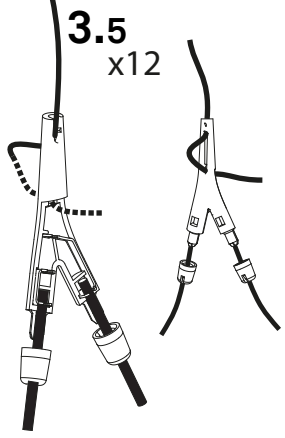
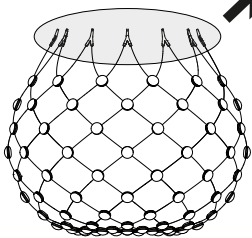
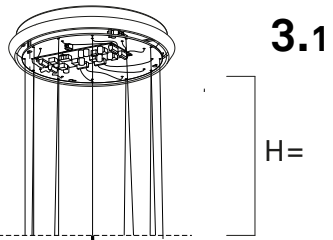

3.2

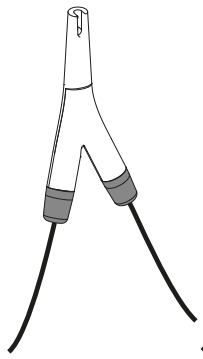

3.3 x12

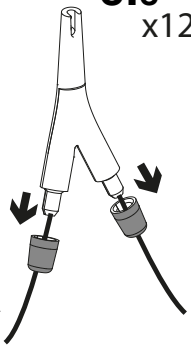

3.4 x12

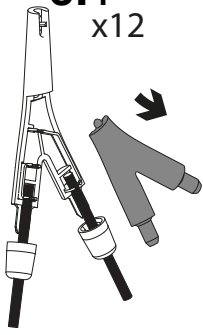

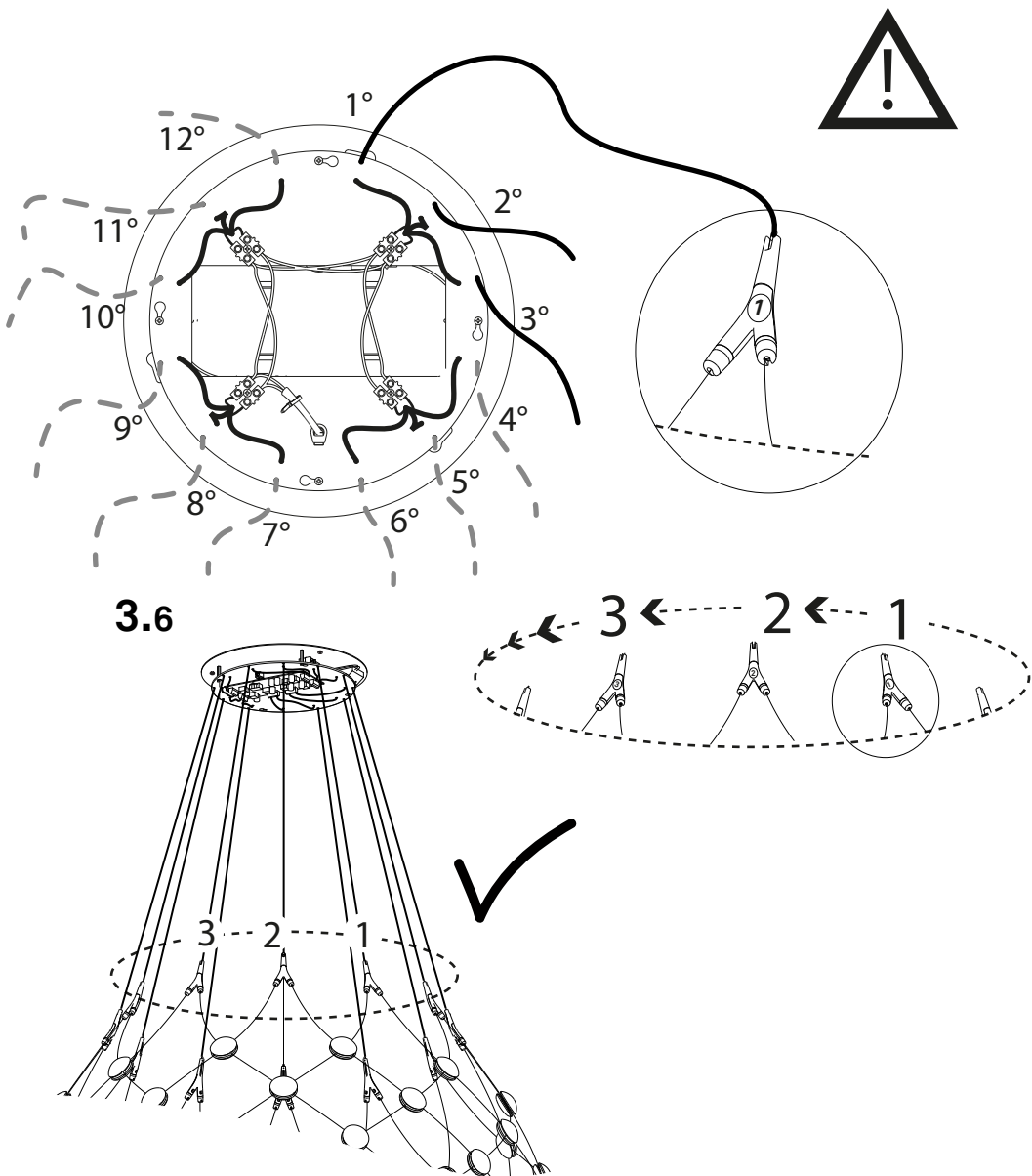

4

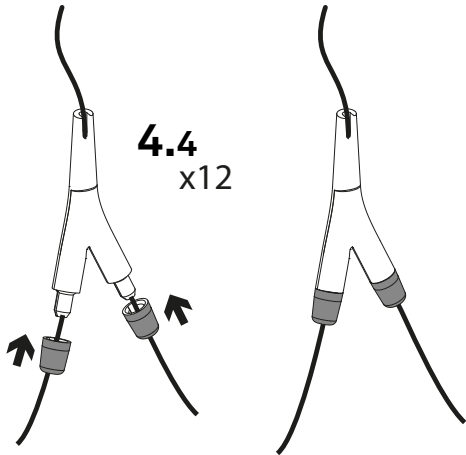
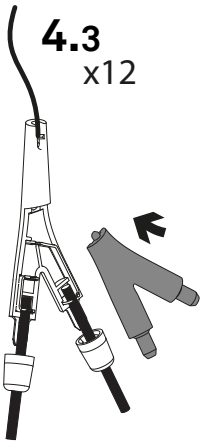
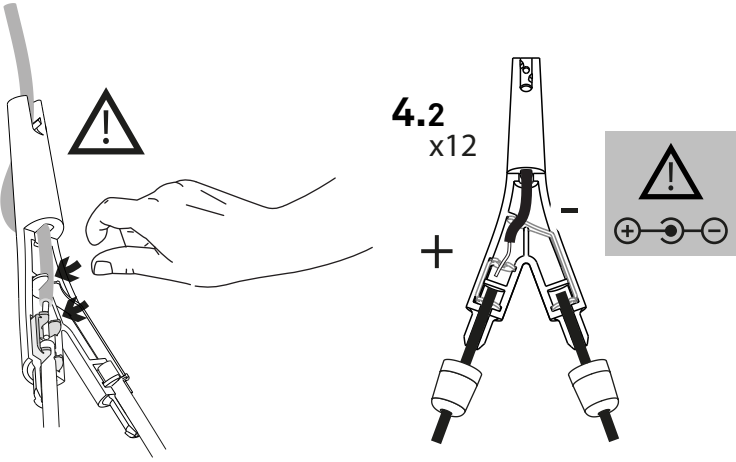
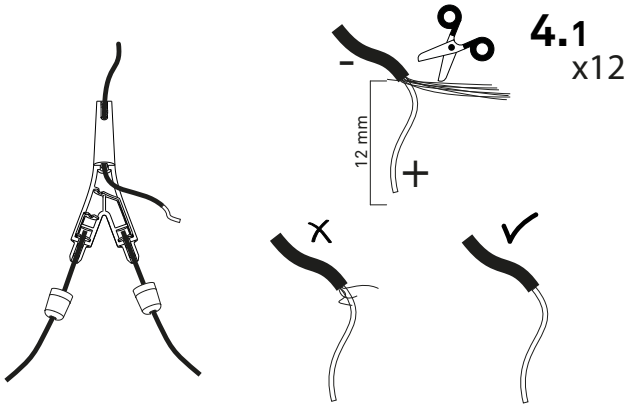

5

D86/T1/1 | D86N
D86/T5/1 |
D86/T1/8 | D86NPI
D86/T5/8 |

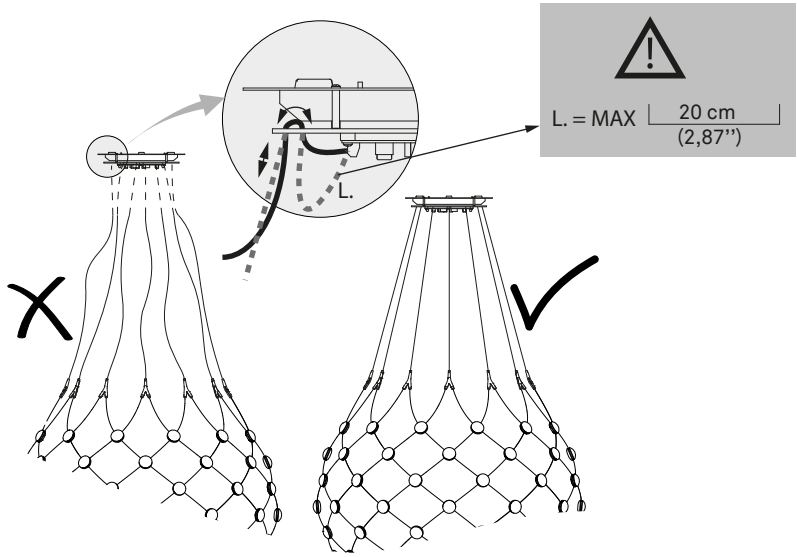
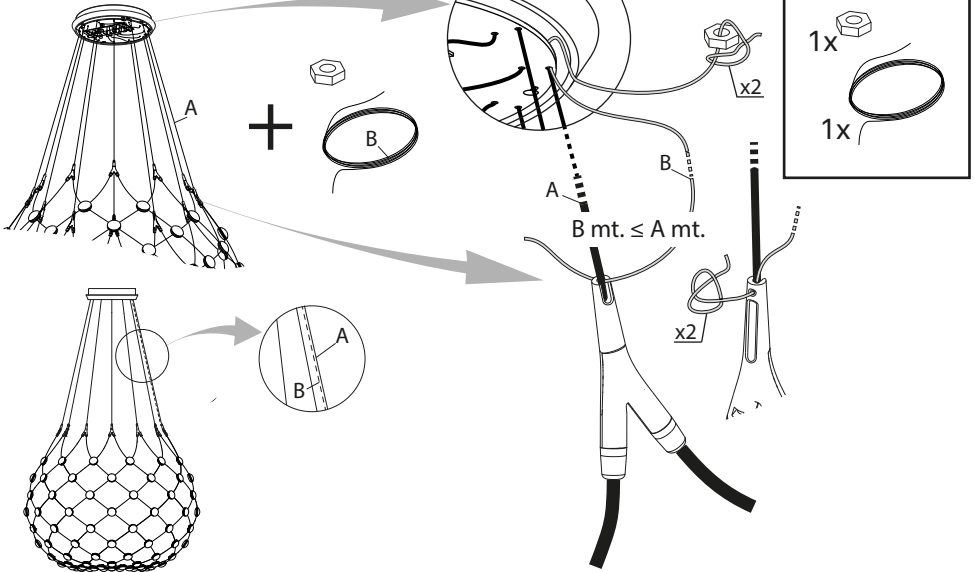

6

D86/T1/1 | D86N
D86/T5/1 |

D86/T1/8 | D86NPI
D86/T5/8 |

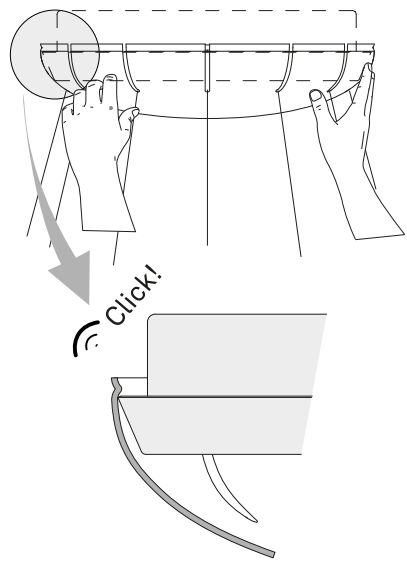
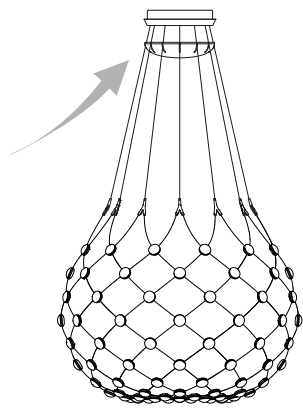
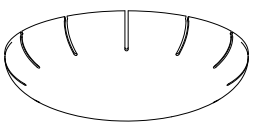

1.

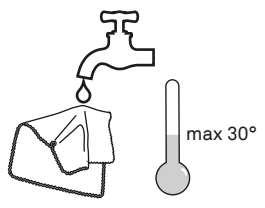

2.



3.

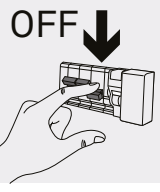
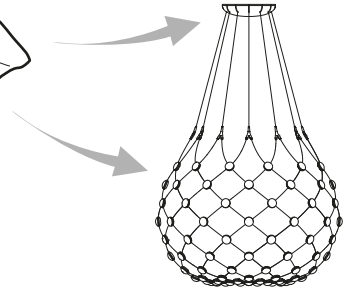
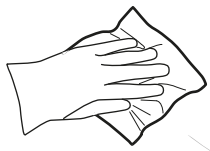



www.luceplan.com

D860I0102